

PRE-AMPLIFIER MIXER

MX-113-EB

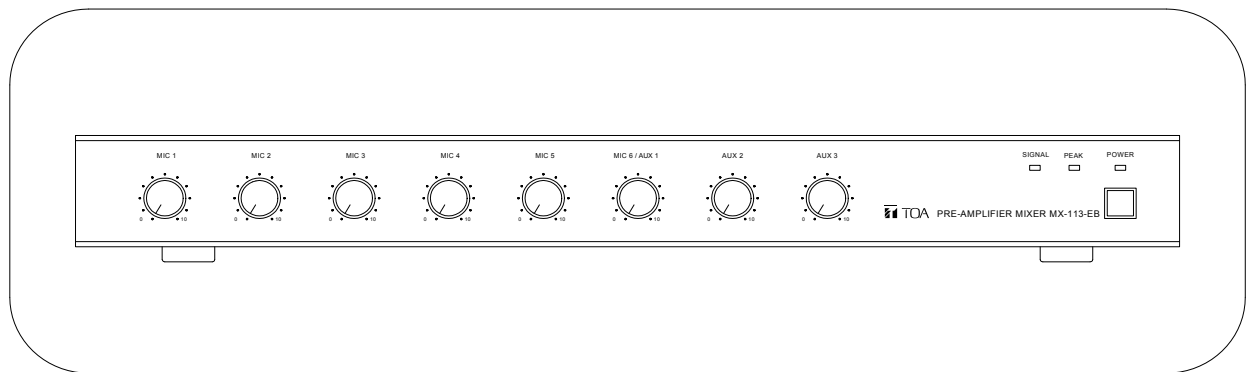

TABLE OF CONTENTS

IMPORTANT SAFETY INSTRUCTIONS ... 2	OPERATIONS
SAFETY PRECAUTIONS 2	Connect to a wired microphone 8
GENERAL DESCRIPTION 4	Connect to a wireless microphone 8
FEATURES 5	BALANCED INPUT 9
ABOUT THE VOICE SWITCH FUNCTION	SETTING THE VOICE SWITCH ON/OFF ...10
How to use the voice switch 5	CIRCUIT DIAGRAM 11
NOMENCLATURE AND FUNCTIONS	EXTERNAL DIMENSIONS12
Front 6	SPECIFICATIONS12
Rear 6	Accessories12
Bottom 6	Optional items12
CONNECTIONS	
Connection example 7	
Remote terminal connection 7	

Thank you for purchasing the TOA mixer amplifier.

Please carefully follow the instructions in this manual to ensure long, trouble-free use of your equipment.

IMPORTANT SAFETY INSTRUCTIONS

- Read these instructions.
- Keep these instructions.
- Heed all warnings.
- Follow all instructions.
- Do not use this apparatus near water.
- Clean only with dry cloth.
- Do not block any ventilation openings. Install in accordance with the manufacturer's instructions.
- Do not install near any heat sources such as radiators, heat registers, stoves, or other apparatus (including amplifiers) that produce heat.
- Do not defeat the safety purpose of the polarized or grounding-type plug. A polarized plug has two blades with one wider than the other. A grounding type plug has two blades and a third grounding prong. The wide blade or the third prong are provided for your safety. If the provided plug does not fit into your outlet, consult an electrician for replacement of the obsolete outlet.
- Protect the power cord from being walked on or pinched particularly at plugs, convenience receptacles, and the point where they exit from the apparatus.
- Only use attachments/accessories specified by the manufacturer.
- Use only with the cart, stand, tripod, bracket, or table specified by the manufacturer, or sold with the apparatus. When a cart is used, use caution when moving the cart/apparatus combination to avoid injury from tip-over.



- Unplug this apparatus during lightning storms or when unused for long periods of time.
- Refer all servicing to qualified service personnel. Servicing is required when the apparatus has been damaged in any way, such as power-supply cord or plug is damaged, liquid has been spilled or objects have into the apparatus, the apparatus has been exposed to rain or moisture, does not operate normally, or has been dropped.

SAFETY PRECAUTIONS

- Before installation or use, be sure to carefully read all the instructions in this section for correct and safe operation.
- Be sure to follow all the precautionary instructions in this section, which contain important warnings and/or regarding safety.
- After reading, keep this manual handy for future reference.

Safety Symbol and Message Conventions

Safety symbols and messages described below are used in this manual to prevent bodily injury and property damage which could result from mishandling. Before operating your product, read this manual first and understand the safety symbols and messages so you are thoroughly aware of the potential safety hazards.



The exclamation point within an equilateral triangle is intended to alert the user to the presence of important operation and maintenance (servicing) instruction in the literature accompanying the appliance.



WARNING

Indicates a potentially hazardous situation which, if mishandled, could result in death or serious personal injury.

When Installing the Unit

- Do not expose the unit to rain or an environment where it may be splashed by water or other liquids, as doing so may result in fire or electric shock.
- Use the unit only with the voltage specified on the unit. Using a voltage higher than that which is specified may result in fire or electric shock.
- Do not cut, kink, otherwise damage nor modify the power supply cord. In addition, avoid using the power cord in close proximity to heaters, and never place heavy objects -- including the unit itself--on the power cord, as doing so may result in fire or electric shock.
- Avoid installing or mounting the unit in unstable locations, such as on a rickety table or a slanted surface. Doing so may result in the unit falling down and causing personal injury and/or property damage.
- External wiring connected to the terminals marked with ⚡ requires installation by an instructed person.
- The apparatus shall be connected to a mains socket outlet with a protective earthing connection.
- The socket-outlet shall be installed near the equipment and the plug (disconnecting device) shall be easily accessible.

When the Unit is in Use

- Should the following irregularity be found during use, immediately switch off the power, disconnect the power supply plug from the AC outlet and contact your nearest TOA dealer. Make no further attempt to operate the unit in this condition as this may cause fire or electric shock.
 - If you detect smoke or a strange smell coming from the unit
 - If water or any metallic object gets into the unit
 - If the unit falls, or the unit case breaks
 - If the power supply cord is damaged (exposure of the core, disconnection, etc.)
 - If it is malfunctioning (no tone sounds.)
- To prevent a fire or electric shock, never open or remove the unit case. Refer all servicing to your nearest TOA dealer.
- Do not place cups, bowls, or other containers of liquid or metallic objects on top of the unit. If they accidentally spill into the unit, this may cause a fire or electric shock.
- Do not insert nor drop metallic objects or flammable materials in the ventilation slots of the unit's cover, as this may result in fire or electric shock.



WARNING

Indicates a potentially hazardous situation which, if mishandled could result in moderate or minor personal injury, and/or property damage.

When Installing the Unit

- Never plug in or remove the power supply plug with wet hands, as doing so may cause electric shock.
- When unplugging the power supply cord, be sure to grasp the power supply plug; never pull on the cord itself. Operating the unit with a damaged power supply cord may cause a fire or electric shock.
- When moving the unit, be sure to remove its power supply cord from the wall outlet. Moving the unit with the power cord connected to the outlet may cause damage to the power cord, resulting in fire or electric shock. When removing the power cord, be sure to hold its plug to pull.
- Avoid installing the unit in humid or dusty locations, in locations exposed to the direct sunlight, near the heaters, or in locations generating sooty smoke or steam as doing otherwise may result in fire or electric shock.
- Be sure to follow the instructions below when rack-mounting the unit. Failure to do so may cause a fire or personal injury.

- Install the equipment rack on a stable, hard floor. Fix it with anchor bolts or take other arrangements to prevent it from falling down.
- When connecting the unit's power cord to an AC outlet, use the AC outlet with current capacity allowable to the unit.
- No rack-mounting screws are supplied with the unit. Separately prepare the appropriate screws for the rack.

When the Unit is in Use

- Do not place heavy objects on the unit as this may cause it to fall or break which may result in personal injury and/or property damage. In addition, the object itself may fall off and cause injury and/or damage.
- Make sure that the volume control is set to minimum position before power is switched on. Loud noise produced at high volume when power is switched on can impair hearing.
- Do not operate the unit for an extended period of time with the sound distorting. This is an indication of a malfunction, which in turn can cause heat to generate and result in a fire.
- If dust accumulates on the power supply plug or in the wall AC outlet, a fire may result. Clean it periodically. In addition, insert the plug in the wall outlet securely.
- Switch off the power, and unplug the power supply plug from the AC outlet for safety purposes when cleaning or leaving the unit unused for 10 days or more. Doing otherwise may cause a fire or electric shock.



The lighting flash with arrowhead symbol, within an equilateral triangle, is intended to alert the user to the presence of uninsulated "dangerous voltage" within the product's enclosure that may be of sufficient magnitude to constitute a risk of electric shock to persons.

- **Clean the unit regularly**

Contact your TOA dealer as to the cleaning. If dust is allowed to accumulate in the unit over along period of time, a fire or damage to the unit may result.

- **Clean the power supply plug**

If dust accumulates on the power supply plug or in the wall AC outlet, a fire may result. Clean it periodically. In addition, insert the plug in the wall outlet securely.

- **During maintenance or leaving the unit unused**

Turn off this unit's power switch, and unplug the power supply plug from the AC outlet for safety purposes when cleaning or leaving the unit unused for 10 days or more. Doing otherwise may cause a fire or electric shock.

GENERAL DESCRIPTION

The MX-113-EB is a desk mount (1 unit size) pre-amplifier mixer that comes with 6 microphone inputs, 4 AUX inputs and 2 monaural output. The microphone 1 to 5 inputs have a signal noise gate circuit that allows a signal to pass through only when it is above a set threshold. It can be mounted in an EIA rack with an optional rack mounting bracket (1U size).

FEATURES

- Up to six microphones can be connected. Alternatively, five microphones and four AUX inputs can be used simultaneously.
- Built-in voice switch function.
- The voice switch.
 - By connecting a DC power supply to this terminal, the amplifier power can be turn on/off remotely.
- Record output.
 - By connecting the record out to any recording devices. The audio from the mixer is recorded.
- Space saving 1U size

ABOUT THE VOICE SWITCH FUNCTION

The voice switch function automatically perform the operation of the microphone On / Off and allow the audio to send out. By using this function, it is not necessary to switch on and off the microphone every time you want to use.

This unit has an independent voice switch circuit build-in onto each input of microphones 1 to 5.

※The factory preset of the voice switch function is at "OFF" position.

How to use the voice switch

- Please turn on the switch when using the microphone with the switch.
- To prevent the voice switch of this unit from activating due to the noise and noise around the microphone, it is designed to work with relatively large sound. Keep the microphone as close to the mouth as possible and speak in a loud voice.



Within 5 cm

※Please speak in a relatively loud voices

[When speaker loud into the microphone]

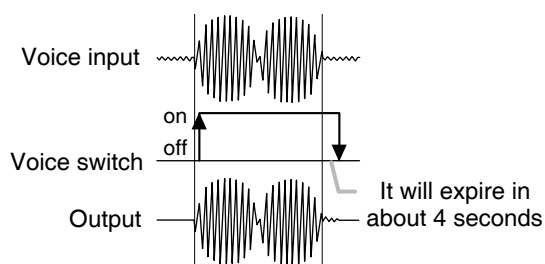

[When speak too soft into the microphone]

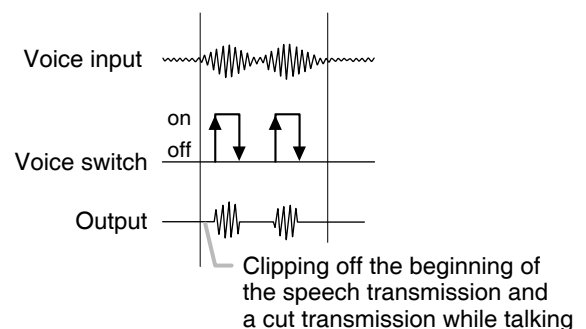

- In the situation where the speaker talks far away from the microphone, the audio output will be intermittent. Please turn off the voice switch function.

※This unit has an voice switch function build-in onto microphone 1 to 5. For more information on how to turn on/off the switch function, refer to page 10 "Setting the voice switch On / Off".

NOMENCLATURE AND FUNCTIONS

[Front]

Microphone 1-5 Volume control knob

Adjusts the volume of the microphone connected to each microphone input terminal.

Output level indicator light

Displays the output level

※ Adjust the volume so that the peak indicator light does not light up even at the maximum.

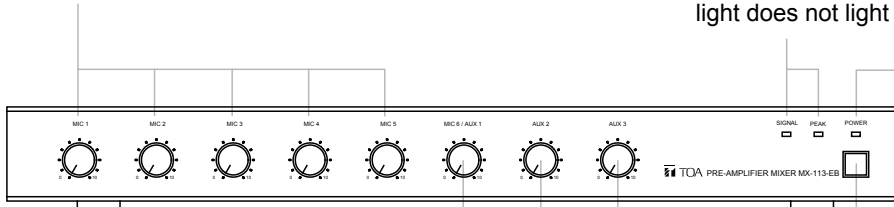

Power indicator light lights up when the power is turned on

Microphone 6 / Auxiliary 1 volume control knob

Adjusts the volume the device connected to the microphone 6 / AUX 1 input.

Power switch

Press to turn on and press again to turn off the power.

Auxiliary 2, 3 volume control knobs

Adjust the volume of the equipment connected to each auxiliary input terminal.

[Rear]

Remote terminal

Connect this terminal to the remote power supply of the PA amplifier. The PA amplifier can be remotely power on or off.

Microphone 6 / Auxiliary 1 input terminal.
Connect either microphone 6 (phone jack) or AUX 1 (RCA Jack).

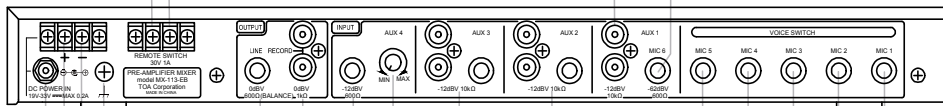

Microphone 1-5 input terminal

Auxiliary 2-3 input terminal. Connect either a audio phone jack or RCA jack.

①: DC power in DC 19-33V

Auxiliary 4 volume

Auxiliary 4 input terminal

Note: If both terminal are connected, the audio jack will be take priority the RCA jack.

Recording output terminal

Connect this terminal to a recording device.

Line output terminal

Connect to "line input" of PA amplifier.

Safety ground terminal

To prevent shock, please connect this terminal to ground terminal.

②: DC jack, from an optional AD-246 AC adapter

Note: The equipment should be powered by either ① or ②.

[Bottom]

Voice switch function
On / off switch

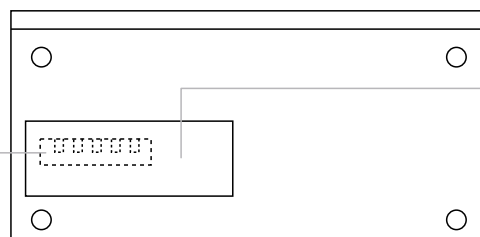

Bottom plate

To set the voice switch function of microphones 1 to 5, remove this bottom plate.

(P. 10)

CONNECTIONS

■ Connection example

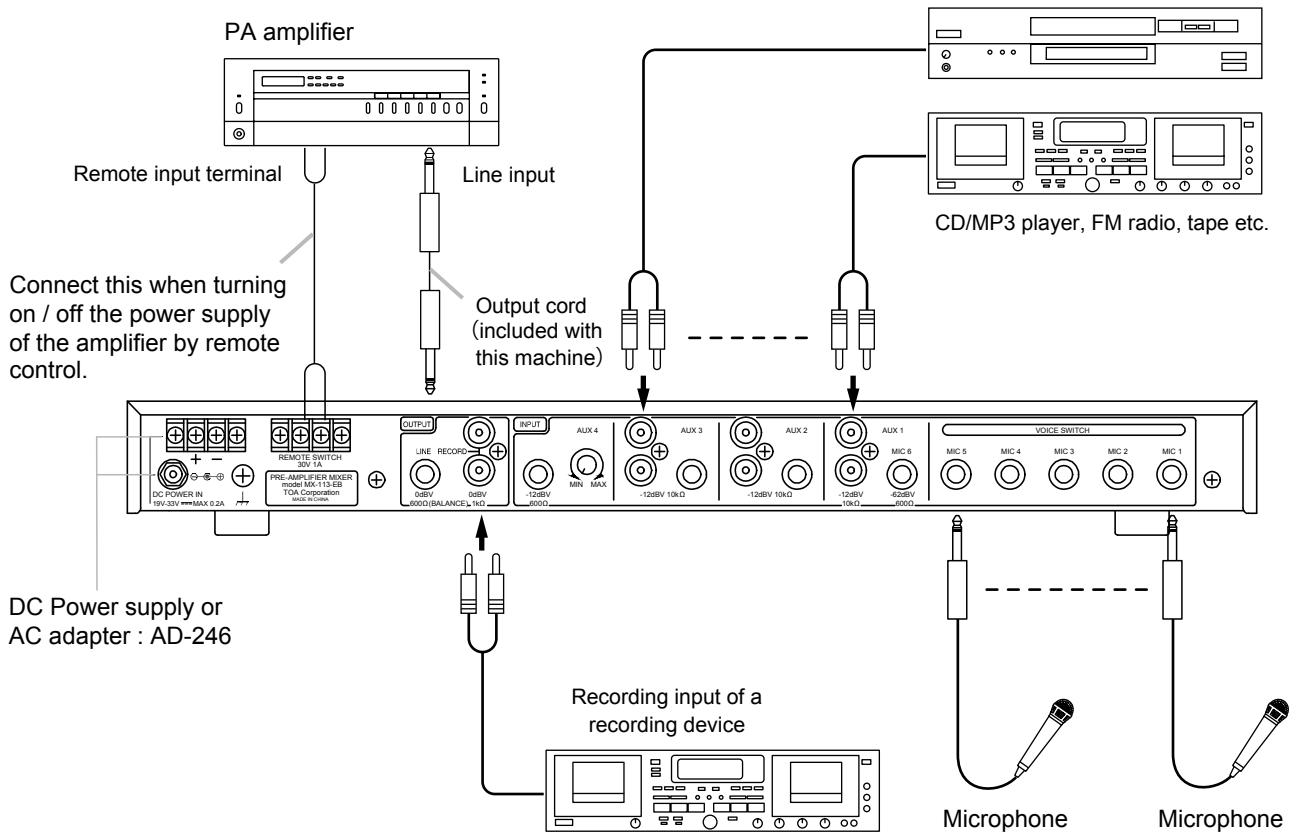

※ Connect the PA amplifier with the included output cord (audio plug / audio plug, 2 m).

■ Remote terminal connection

When the power is turned on, the remote terminal of this unit enters a short condition, and when it is set to "OFF", the remote terminal becomes open.

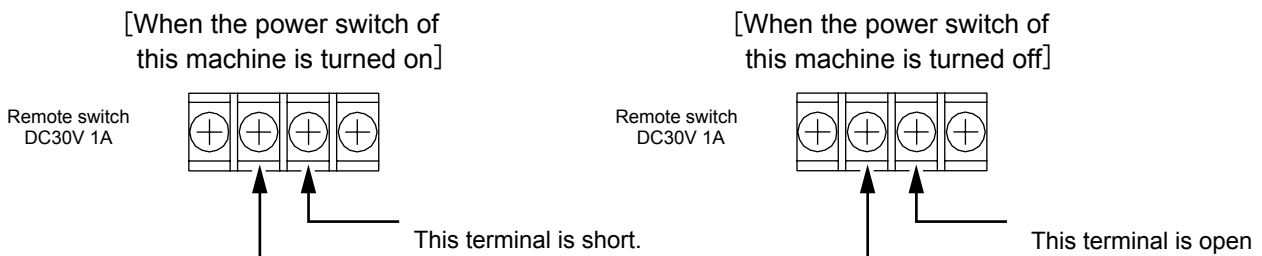

Caution

The rated input power of the remote terminal is DC 30V, 1A. Please do not connect excess power on this terminal.

OPERATIONS

Please check the following before operating.

- The power cord is correctly connected to AD-246 or DC power (DC 19-33V)
- Make sure the line output and line input of the pre-amplifier mixer are correctly connected.
- Set each volume control knobs to minimum "0" position.

■ Connect to a wired microphone

- 1 Connect a microphone to the microphone 1-6 input terminals.

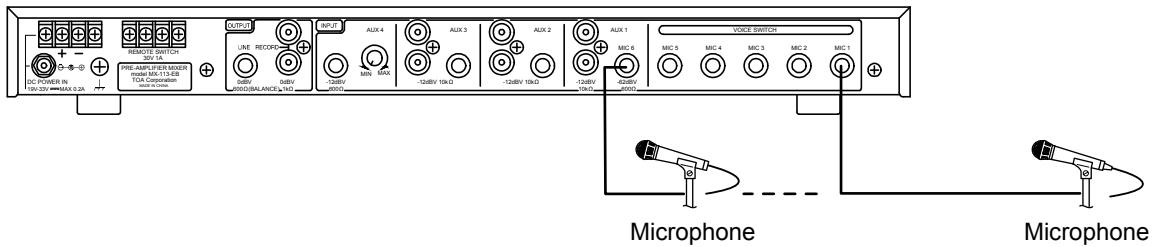

- 2 Turn on the power.
- 3 Turn the volume control on the input connected to the microphone clockwise to adjust the volume to the appropriate volume.

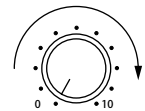

※ When using the voice switch function, set the voice switch function to "ON". (P. 10)

■ Connect to a wireless microphone

- 1 Connect the output of the wireless tuner to the auxiliary input terminal of this unit.

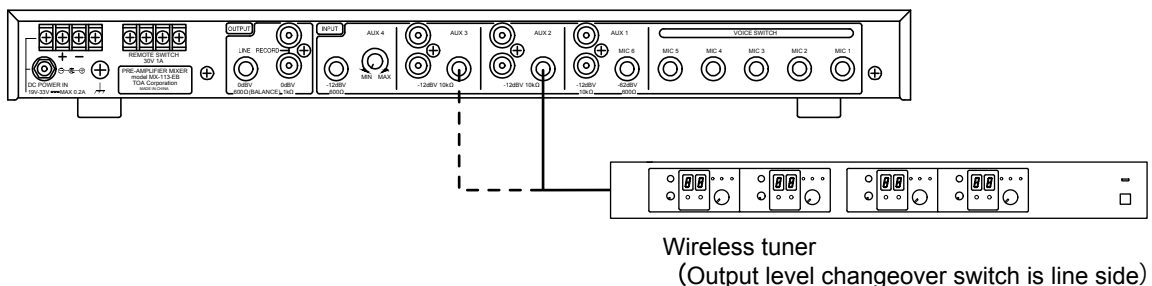

- 2 Turn on the power.
- 3 Adjust the volume control knob to a desire volume that connect to the wireless tuner.

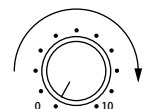

BALANCED INPUT

All the input on this equipment are unbalanced inputs. By installing a separated IT-450 balanced transformer, microphone inputs 1 to 5 and Auxiliary 4 can be balanced. The following procedure below is adding IT-450 balance transformer.

WARNING

Please leave this work to a professional expert. There is a high voltage component inside, and opening or modifying the case may cause fire or electric shock.

- 1 Turn off the power switch of DC power supply equipment and remove the power plug.

WARNING

Please do not work while the power plug is plugged in the outlet. It may cause electric shock.

- 2 Remove the 4 screws on both sides of the machine and remove the case.

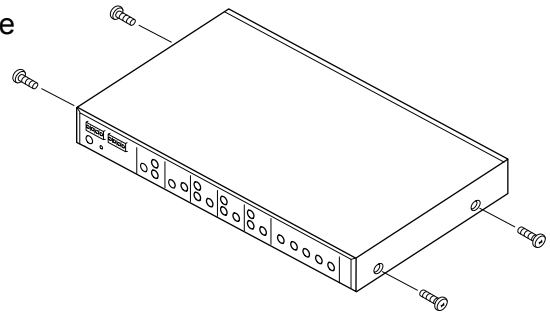

- 3 Unscrew the 3 screws on the the bottom of the unit and remove the bottom plate.

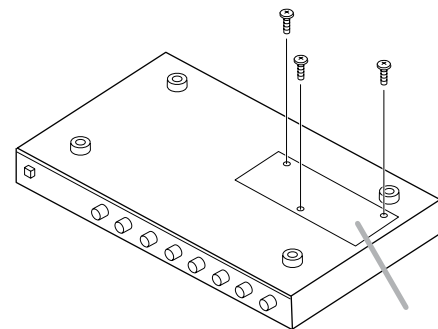

Bottom plate

- 4 Use a nipper or similar tool to cut the 2 jumpers wire corresponding to the inputs that is to be balanced. (Jumper lines are indicated by the arrows below.)

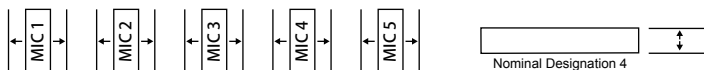

Caution

Make sure that the cut jumper wires do not touch each other.

5 Install IT-450

5-1 Inserts the IT-450 onto the upper surface of the PCB board.

5-2 Solder from the back side of the board.

5-3 Trims the IT-450 leads

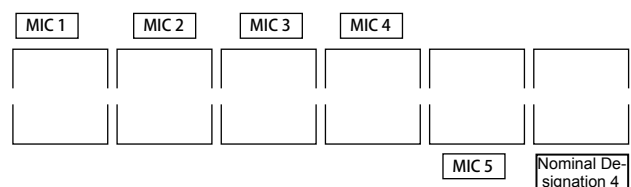

- 6 Cover back the plate and case.

SETTING THE VOICE SWITCH ON/OFF

The voice switch function is built into microphone 1-5 circuits, and the function is set with voice switch function ON / OFF switch.

※The factory setting is "OFF".

- 1 Turn off the power switch of DC power supply equipment and remove the power plug.



WARNING

Please do not open the bottom plate while the power plug is plugged into the AC outlet. It may cause electric shock.

- 2 Remove the three screws on the bottom of the unit and remove the bottom plate.

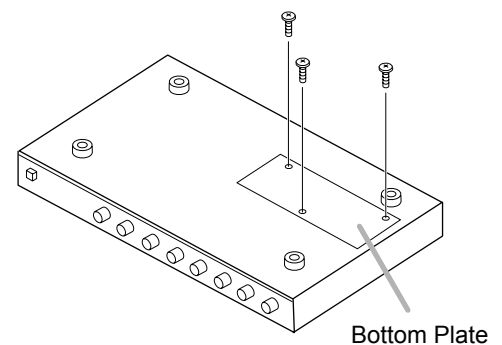

- 3 Set the voice switch function ON / OFF switch.

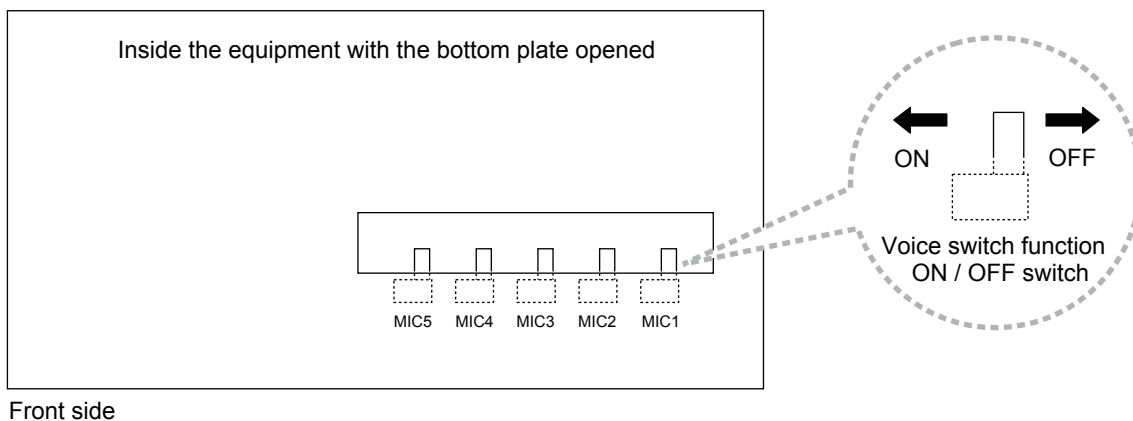

- 4 Cover the bottom plate and tighten back the screws.

CIRCUIT DIAGRAM

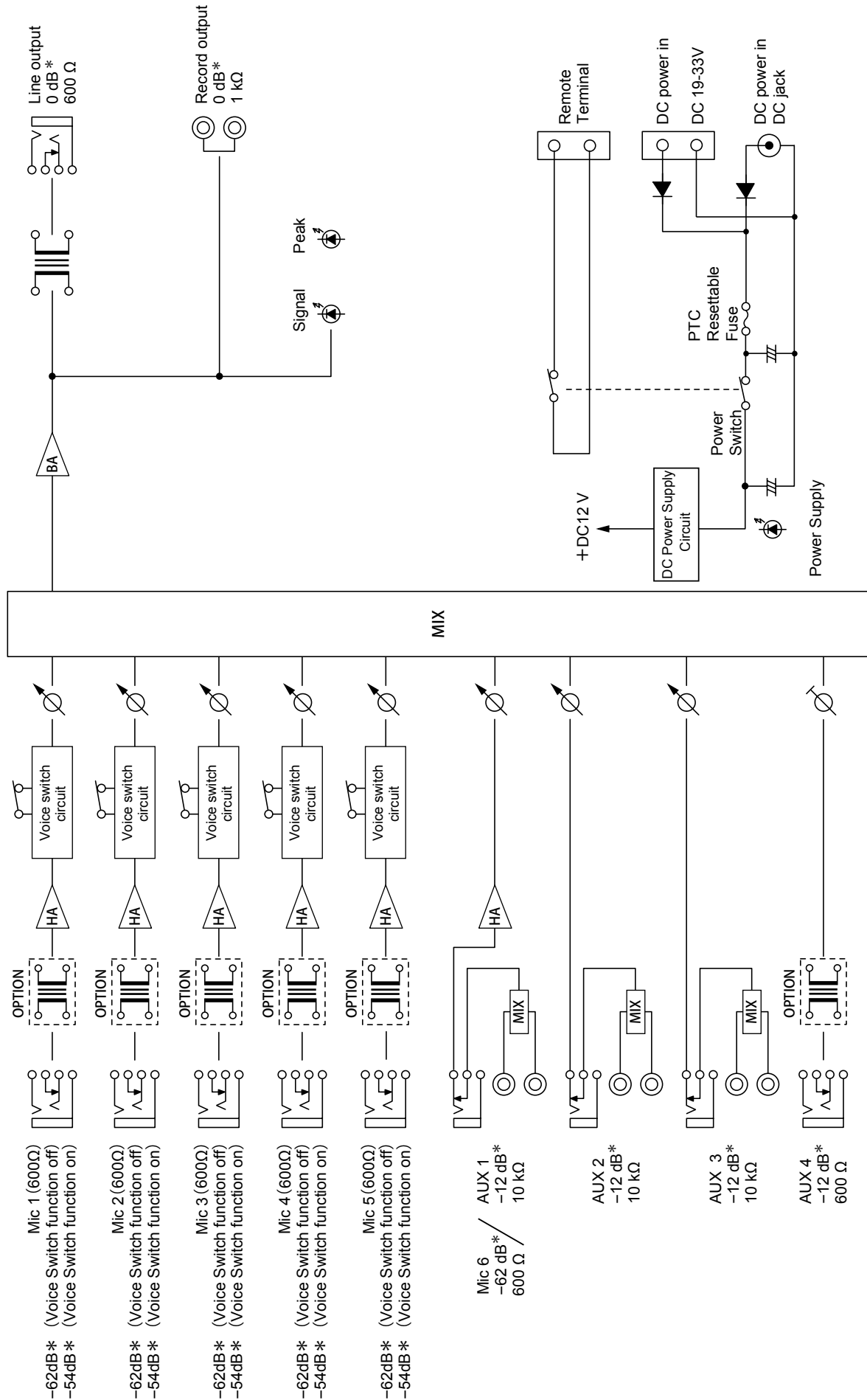

* 0 dB = 1 V

EXTERNAL DIMENSIONS

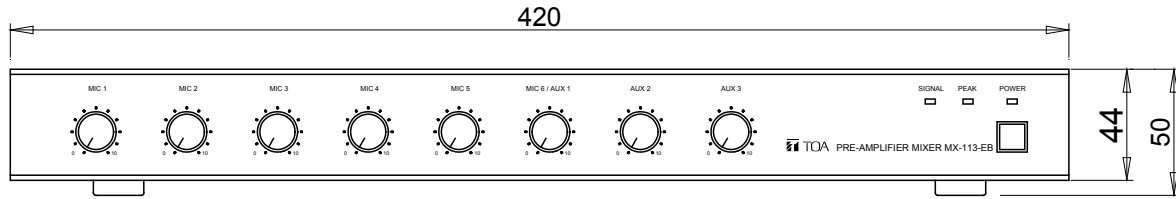

FRONT VIEW

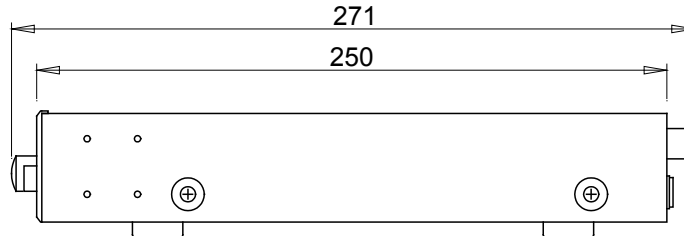

SIDE VIEW

SPECIFICATIONS

Power Source	DC 19-33V, DC power in : M3 screw terminal, Barrier interval : 6.4mm DC jack, from an optional AD-246 AC adapter
Current Consumption	Max 0.2A
Input	Mic 1-5 : 600Ω, -62dB* (voice switch OFF), unbalanced, phone jack 600Ω, -54dB* (voice switch ON), unbalanced, phone jack (option IT-450 balance transformer) Mic 6 : 600Ω, -62dB*, unbalanced, phone jack AUX 1 : 10kΩ, -12dB*, unbalanced, RAC jack AUX 2,3: 10kΩ, -12dB*, unbalanced, phone/RAC jack AUX 4 : 600Ω, -12dB*, unbalanced, phone jack (option IT-450 balance transformer)
Output	Line output : 600Ω, 0dB*, balance transformer, phone jack Record out : 1kΩ, 0dB*, unbalanced, RAC jack
Remote Terminal	Withstand voltage : DC30V, Current : 1A, M3 Screw terminal Barrier interval : 6.4mm
T.H.D	1 % or less (1 kHz, rated output)
Frequency Response	30 Hz - 20 kHz
Noise Level	60 dB
Operating Temperature	0 °C to + 40 °C (32 °F to 104 °F)
Operating Humidity	90 % RH or less (no condensation)
Finish	Front Panel : Aluminum, Black, Paint Case : Steel plate, Black, Paint
Dimensions	420 (W) X 50 (H) X 271 (D) mm (16.54" X 1.97" X 10.67")
Weight	2.8 kg (6.17 lb)
Option	AC adapter : AD-246, Rack mount bracket : MB-15B

* 0 dB = 1 V

※ Specifications and appearance of this machine are subject to change without notice due to improvements.

● Accessories

Output cord (audio plug / audio plug, 2 m) 1